

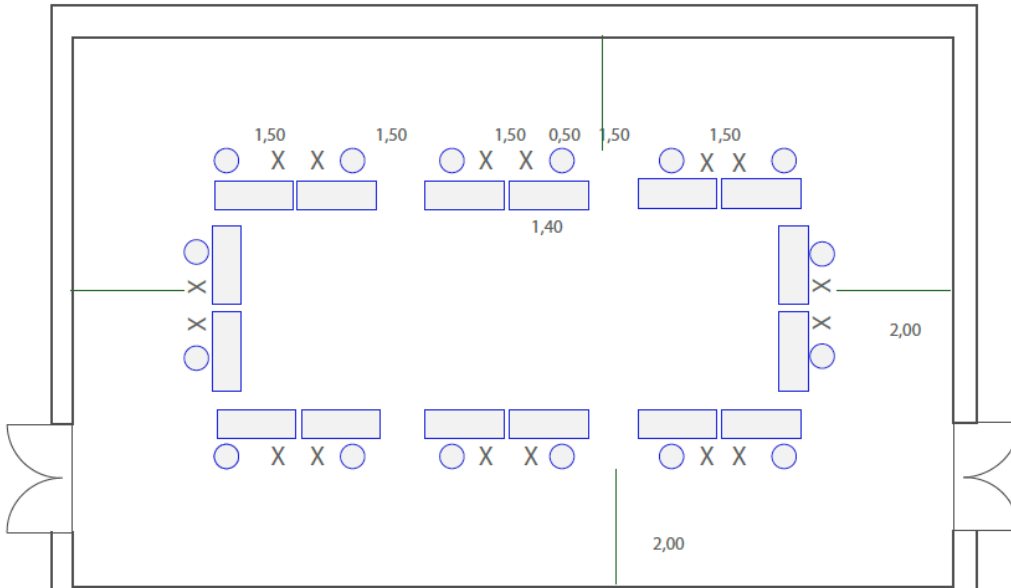

BAUKUNSTARCHIV
NRW

Bestuhlungspläne für den Gartensaal und den Reinoldi-Lichthof
gemäß *Coronaschutzverordnung* (CoronaSchVO)





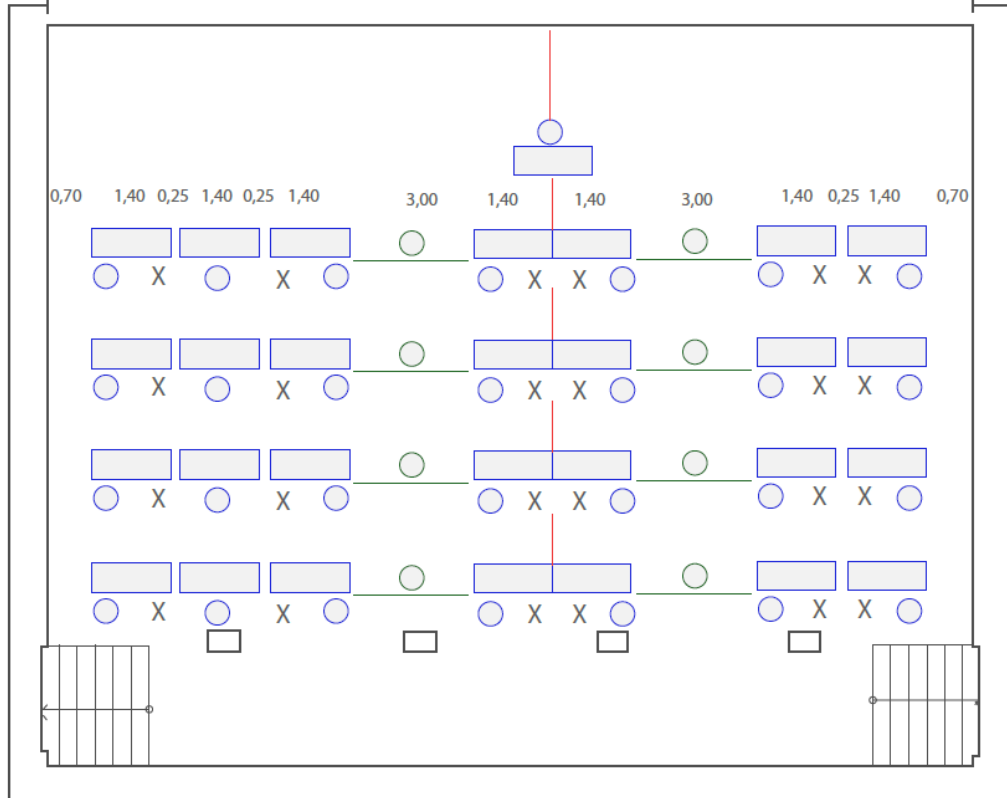

Gartensaal ca. 152m²
Teilnehmerzahl max. 16 Personen

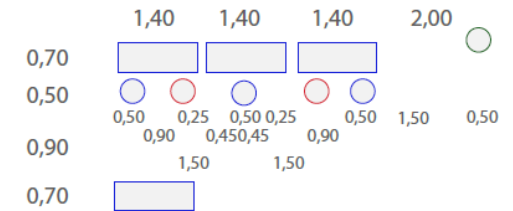

Lichthof ca. 171m²
Teilnehmerzahl max. 29 Personen



-  Tische 1,40m x 0,70m
-  Stühle 50 cm
-  X Abstandsfläche
-  — Erschließung 1,50m + 50 cm



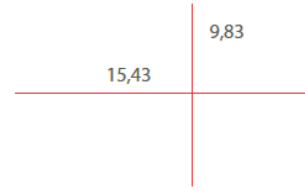
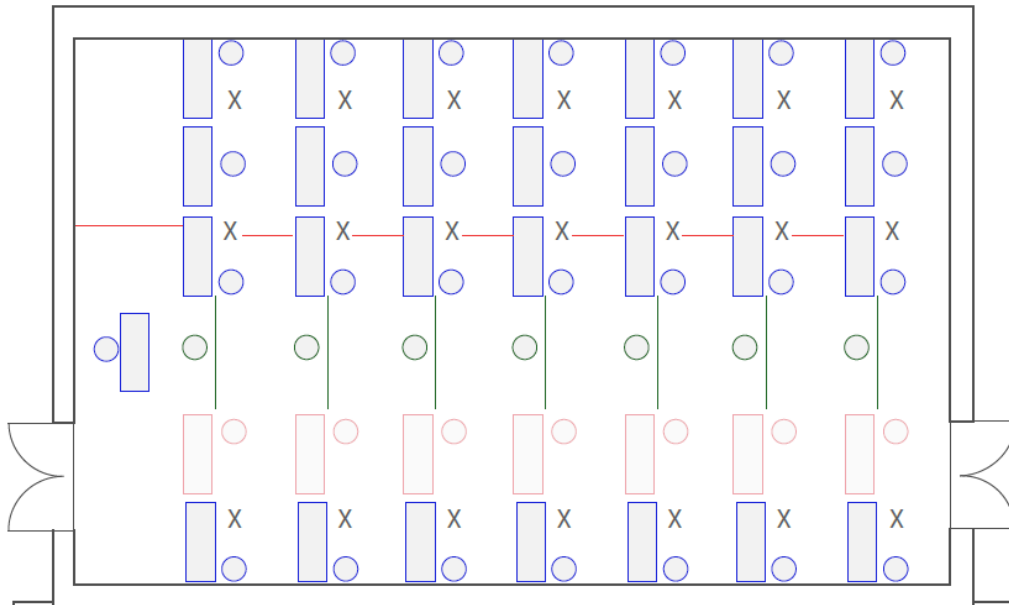

Gartensaal ca. 152m²
max. 29 Personen

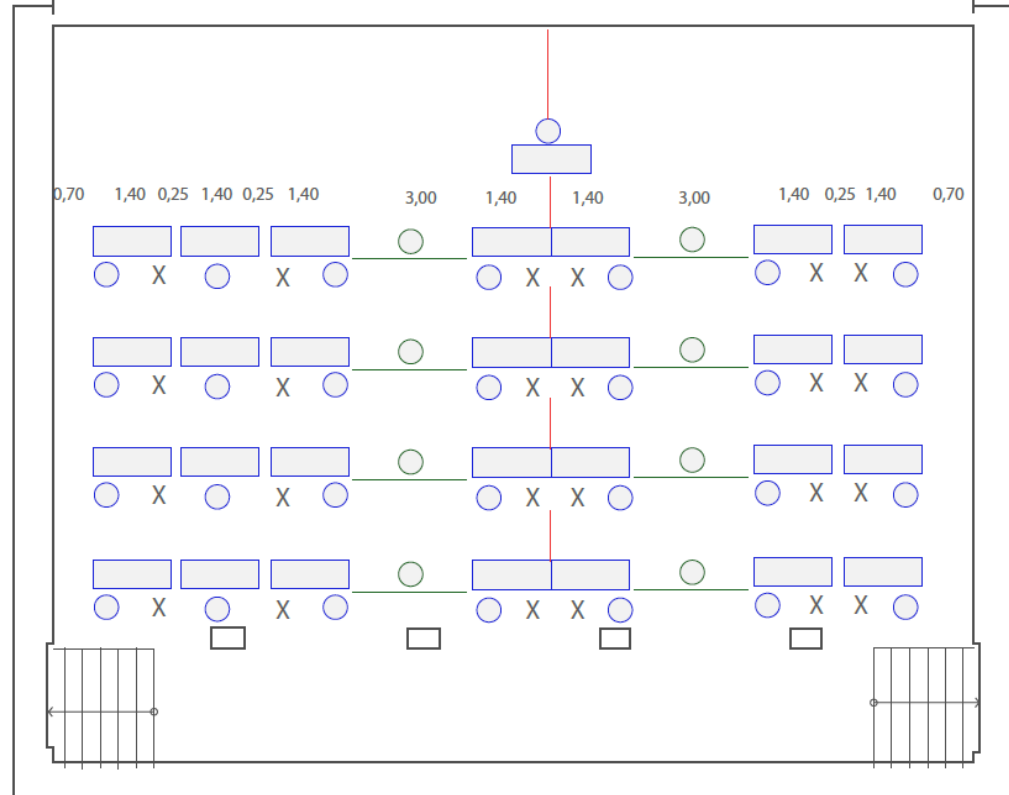

Lichthof ca. 171m²
Teilnehmerzahl max. 29 Personen

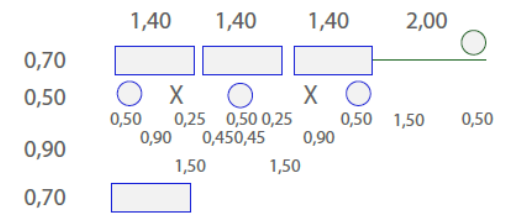

- Tische 1,40m x 0,70m
- Stühle 50 cm
- X Abstandsfläche
- Erschließung 1,50m + 50 cm

